

SLIGHT

KING CATALOGUE

2025

slightly different



Slight[®]
slightly different

KING

KING series has a deep anti-glare design, shade angle of 35°, narrow edge design 5mm, with excellent optical design, patented lens design, multiple optical options, the highest light effect of 100LM/W, luxury villas and star hotels, light spot uniformity and soft. The product's full metal design and anti-light leakage design meets the designer's ultimate pursuit of product application.





Patented lens design

Bessel's internal hole mixing design provides a delicate and smooth transition of the wallwashing spot with precise control of each beam of light.

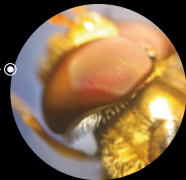
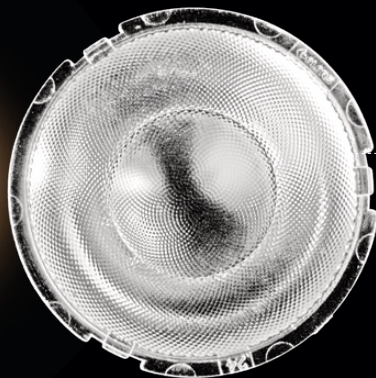
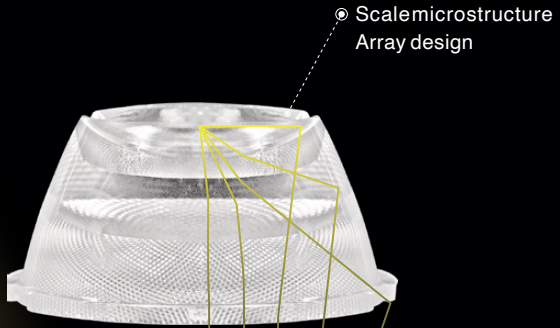

Fermat Curve
Microstructure
Black light tech
design

Deep anti-glare High efficiency



100LM/W

UGR < 1

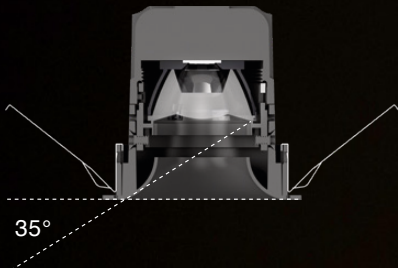

(The picture is the actual effect of 15W, King series)

slightly different

Superior industrial design

Technological and natural aesthetics combined



Sports Cars

Taking a cue from BMW's concept sports car, it inherits its futuristic and technological feel.



Rock

The product has the layers and hard appearance of mountain rock, and the coldness highlights the product's focus on function.

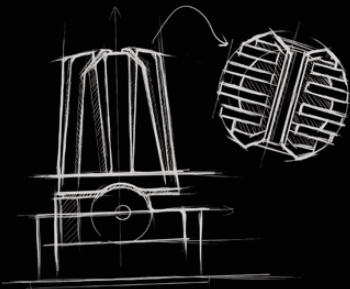

Full metal body design. Small size, high power

More exquisite appearance, better
heat dissipation performance using
new zinc alloy material
Max. power 17W

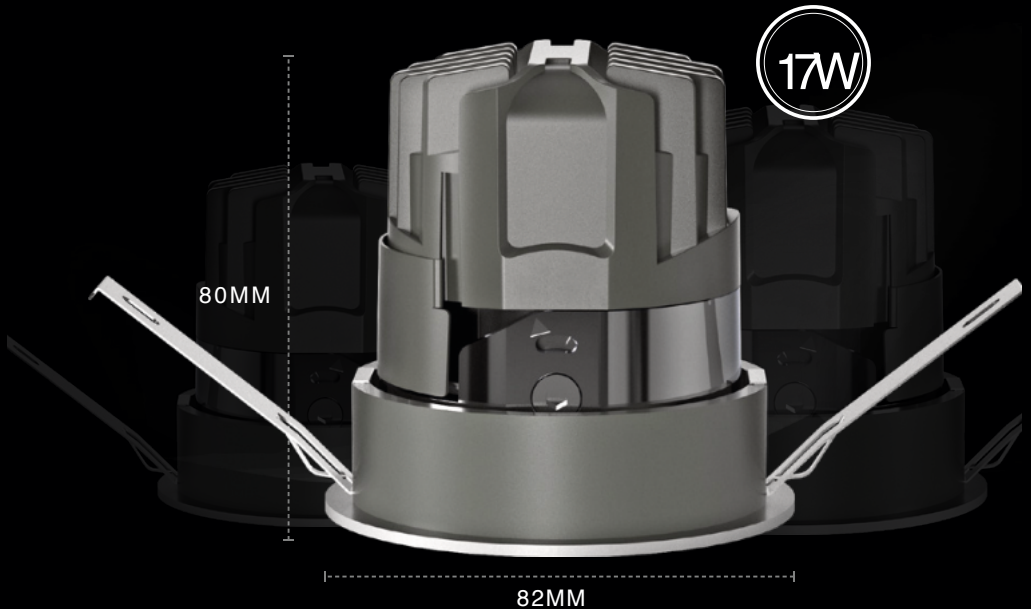
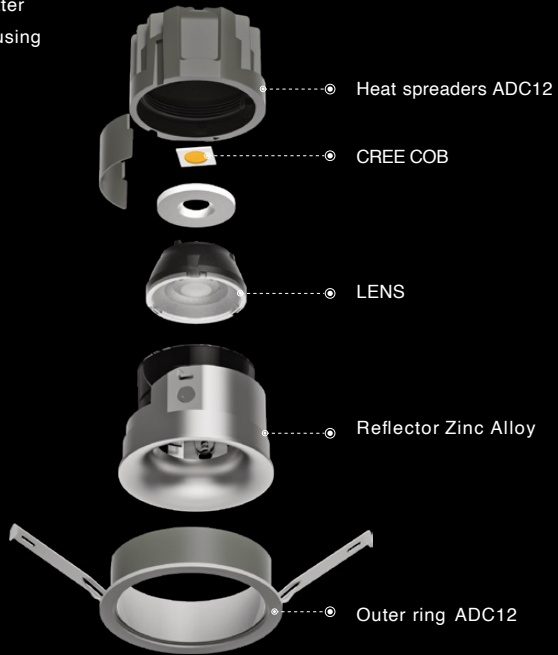

Rigorous thermal design management

Longer luminaire life, reliable and stable quality

COB



TCPoint

LEDDownlight Heat Dissipation Simulation

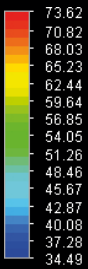

Temperature °C



Curve of TCpoint temperature after lighting

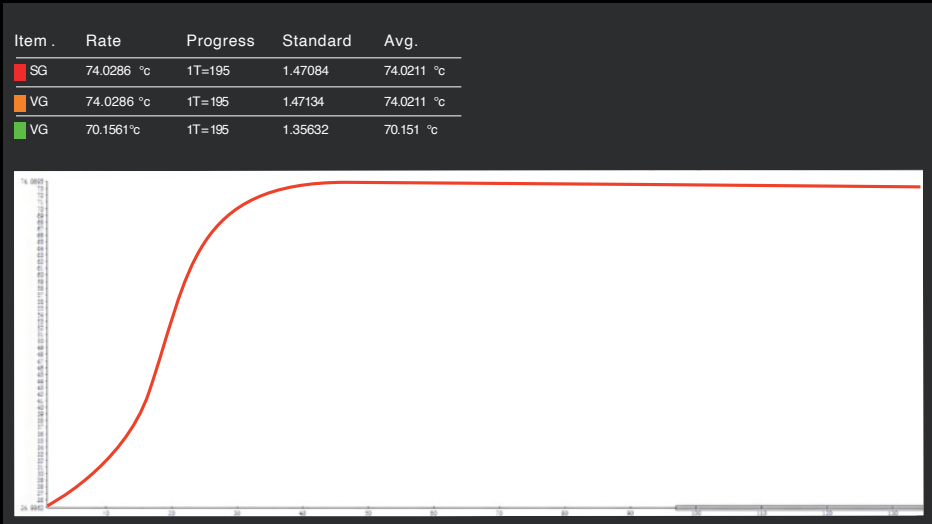

Strict manufacturing process

Stronger heat dissipation ability

Downlight radiator section

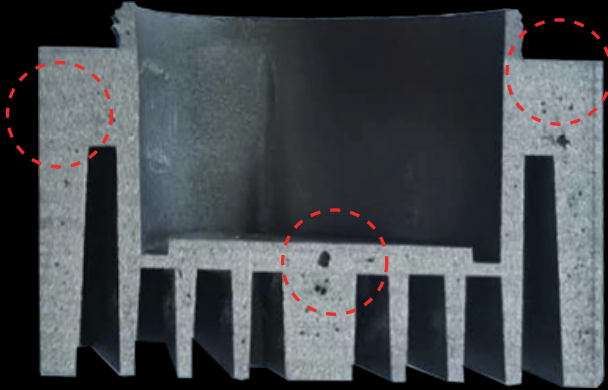

Competitor's

Downlight radiator
section COLORS

VS

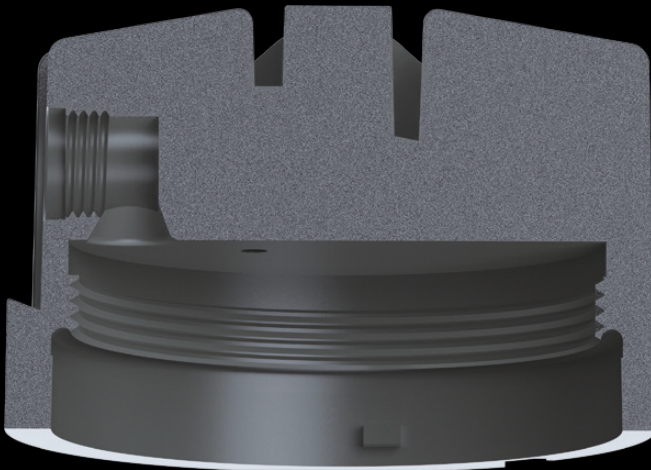

COLORS

Modular design

Multiple optics options
multiple reflectors available

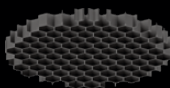

Mirror



Black Chrome



Matt white



Matt black



Champagne Gold

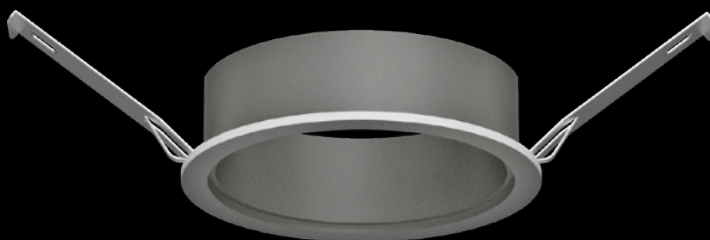

Black Border



White Border

Split design

Split design, easy to replace the reflector and radiator modules, easy maintenance, without damaging the ceiling.

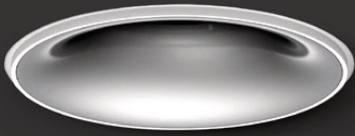

Mechanical angle adjustment

Anti-light leakage structure design

Mechanical adjustable angle, with a good degree of tension.

Anti-light leakage structure design, so that the light out of a more efficient design

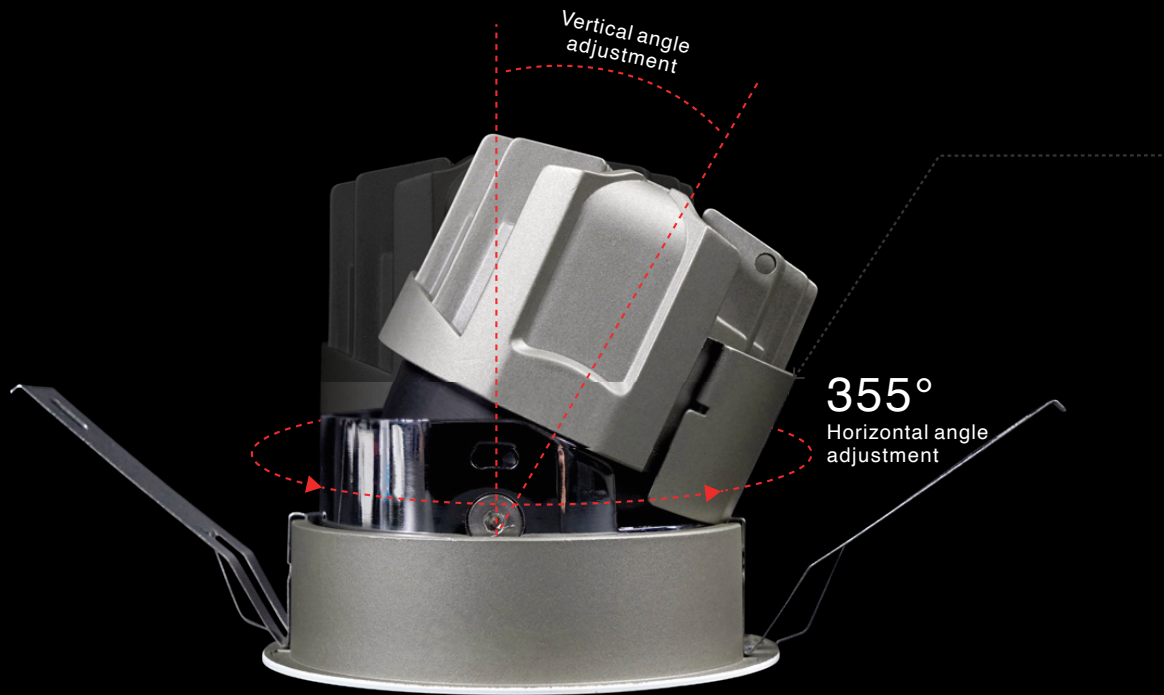



Light barrier design



Application

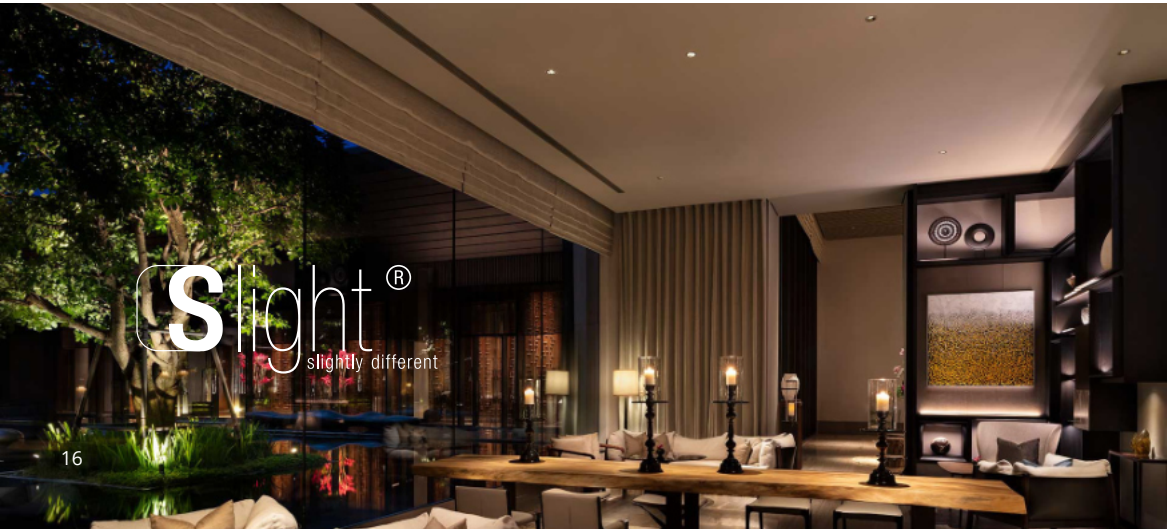

Slight[®]
slightly different



Product list



KE55L2



KR55L2



Slight[®]
slightly different

Model	Size	Opening size	Light source	IP grade	Border Color	Reflector Color	CRI	Input voltage	Input Current	Power	Beam angle	CCT	Luminous flux
KE55L2 KR55L2	Φ62*H74.5mm Φ80*H74.5mm	Φ55mm	COB	IP20	White Black	Mirror Black chrome Matte black Matte white Champagne Gold	> 90RA	220- 240VAC	150mA	6W	15°	2700K	320
												3000K	340
												4000K	365
											24°	2700K	375
												3000K	395
												4000K	425
											36°	2700K	425
												3000K	450
												4000K	480
											42°	2700K	400
												3000K	420
												4000K	450
									200mA	8W	15°	2700K	430
												3000K	455
												4000K	485
											24°	2700K	505
												3000K	530
												4000K	570
											36°	2700K	570
												3000K	600
												4000K	640
											42°	2700K	530
												3000K	560
												4000K	570
250mA	10W	15°	2700K	505									
			3000K	530									
			4000K	570									
		24°	2700K	600									
			3000K	630									
			4000K	675									
		36°	2700K	615									
			3000K	650									
			4000K	695									
		42°	2700K	625									
			3000K	660									
			4000K	705									

Product list



KE75L2



KR75L2



Slight[®]
slightly different

Model	Size	Opening size	Light source	IP grade	Border Color	Reflector Color	CRI	Input voltage	Input Current	Power	Beam angle	CCT	Luminous flux	
KE75L2 KR75L2	φ82*H80mm φ100*H80mm	φ55mm	COB	IP20	White Black	Mirror Black chrome Matte black Matte white Champagne Gold	> 90RA	220- 240VAC	200mA	8W	15°	2700K	430	
												3000K	455	
												4000K	485	
											24°	2700K	645	
												3000K	680	
												4000K	725	
										38°	2700K	720		
											3000K	760		
											4000K	815		
										50°	2700K	655		
											3000K	690		
											4000K	740		
									11W		2700K	425		
											3000K	450		
											4000K	480		
									250mA	10W	15°	2700K	540	
												3000K	570	
												4000K	610	
											24°	2700K	800	
												3000K	840	
												4000K	900	
										38°	2700K	855		
											3000K	900		
											4000K	965		
										50°	2700K	815		
											3000K	860		
											4000K	920		
									300mA		12W	15°	2700K	615
													3000K	910
													4000K	695
										24°		2700K	890	
												3000K	935	
												4000K	1000	
										38°	2700K	1000		
											3000K	1055		
											4000K	1130		
										50°	2700K	910		
											3000K	960		
											4000K	1030		
									350mA		15W	15°	2700K	685
													3000K	720
													4000K	770
										24°		2700K	995	
												3000K	1050	
												4000K	1125	
										38°	2700K	1225		
											3000K	1290		
											4000K	1380		
50°	2700K	1110												
	3000K	1170												
	4000K	1250												
	400mA	17W	15°	2700K	775									
				3000K	815									
				4000K	870									
24°			2700K	1130										
			3000K	1190										
			4000K	1275										
38°		2700K	1385											
		3000K	1460											
		4000K	1560											
50°		2700K	1260											
		3000K	1325											
		4000K	1420											

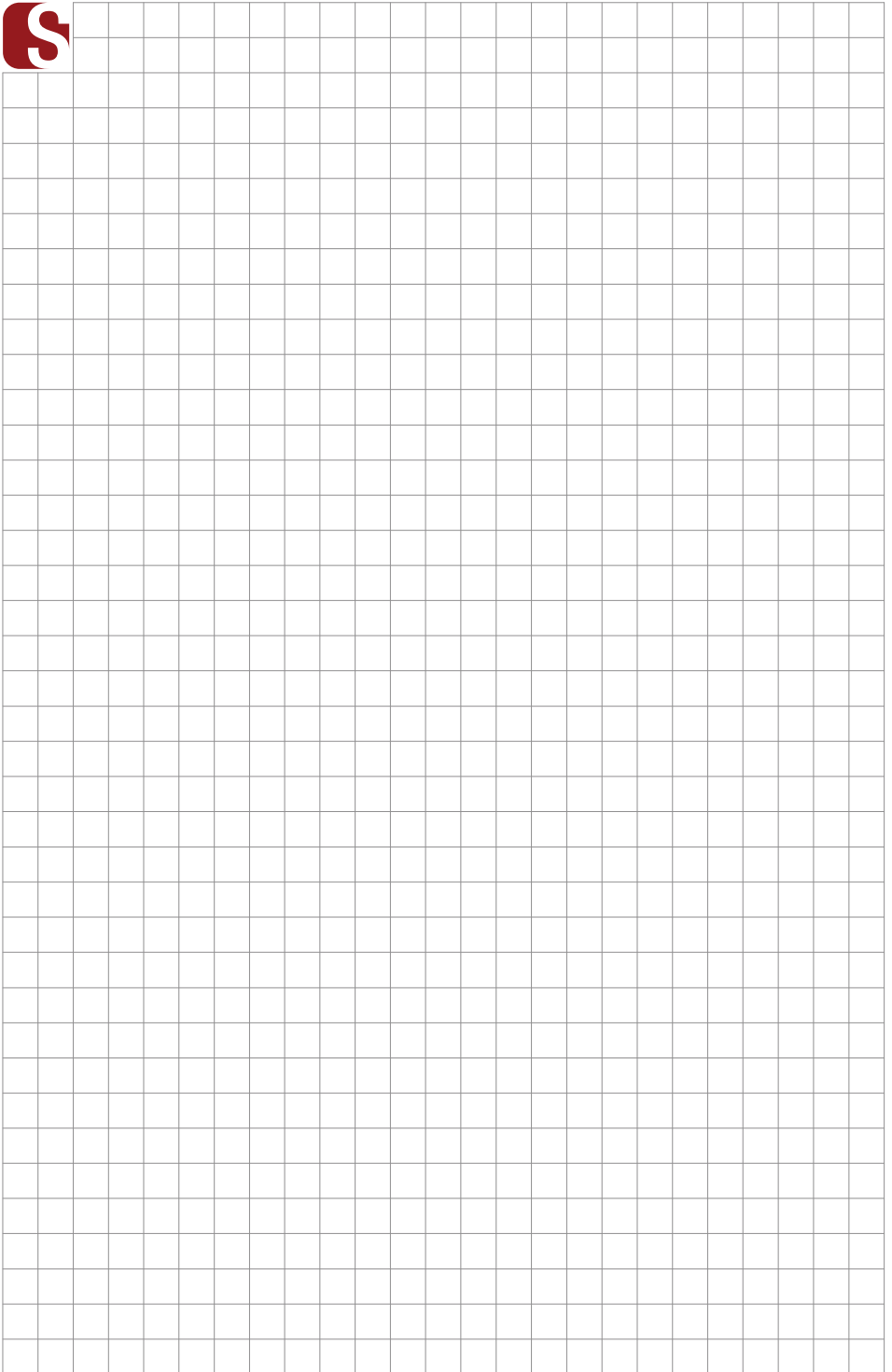

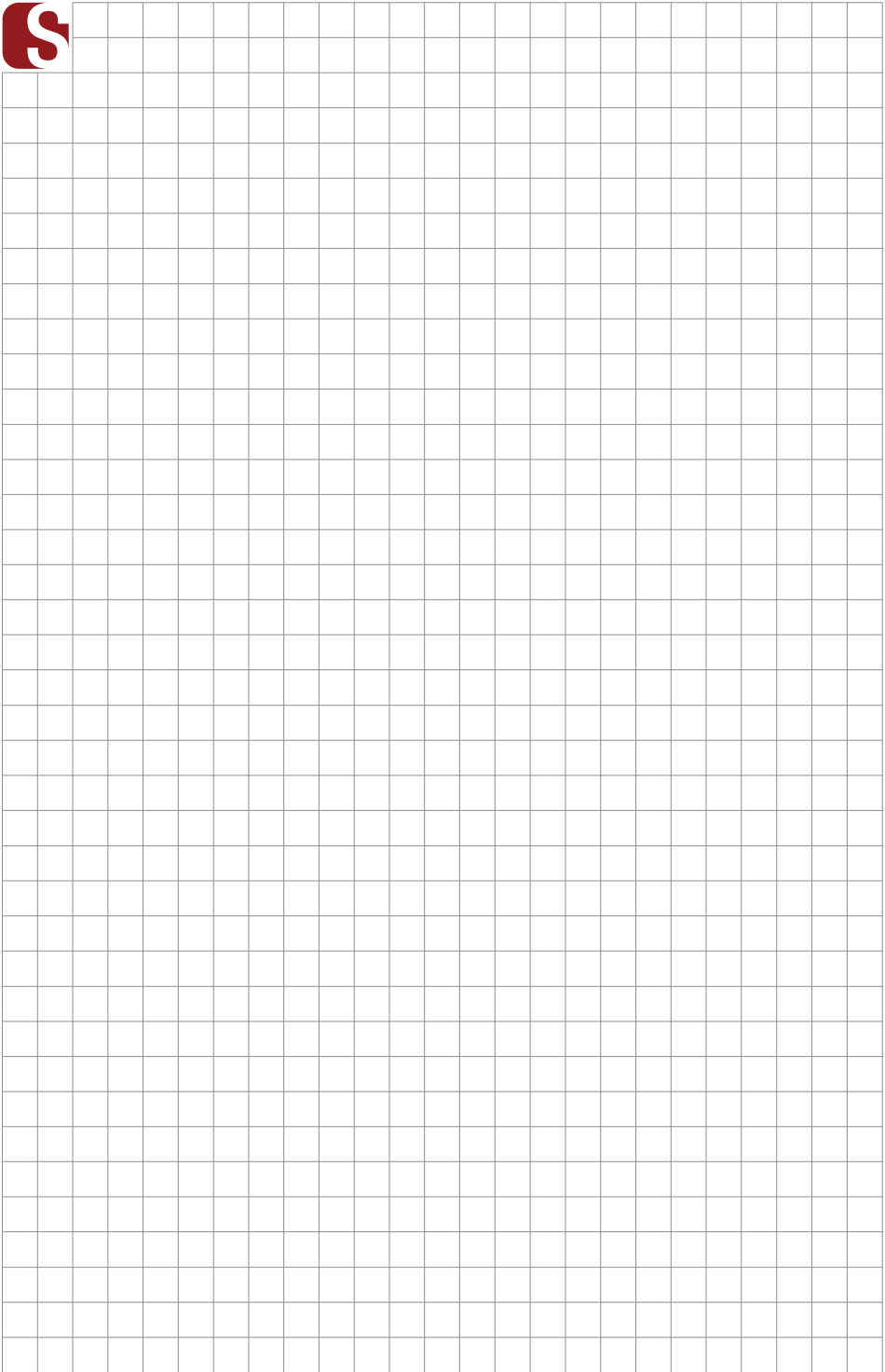

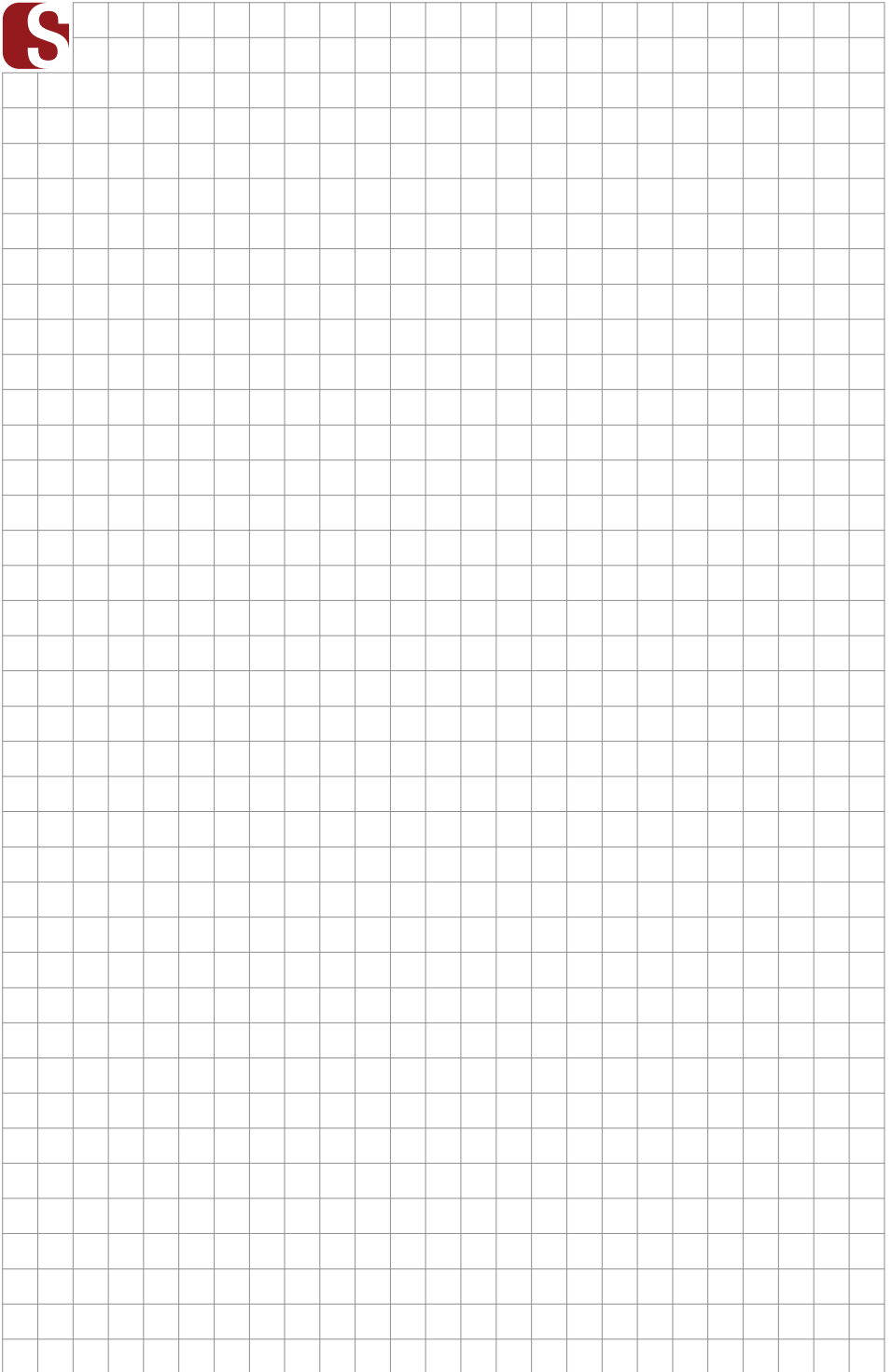

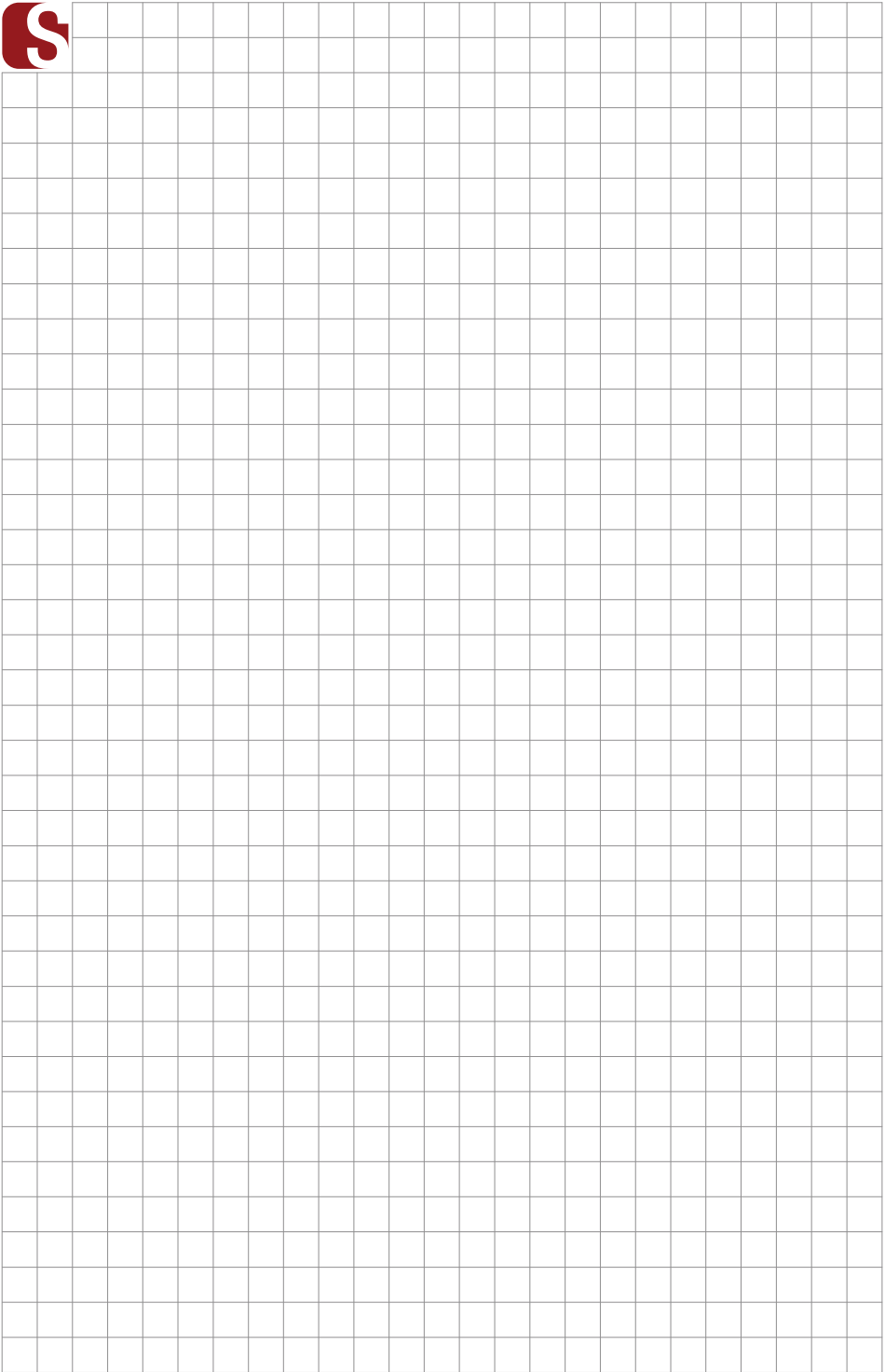

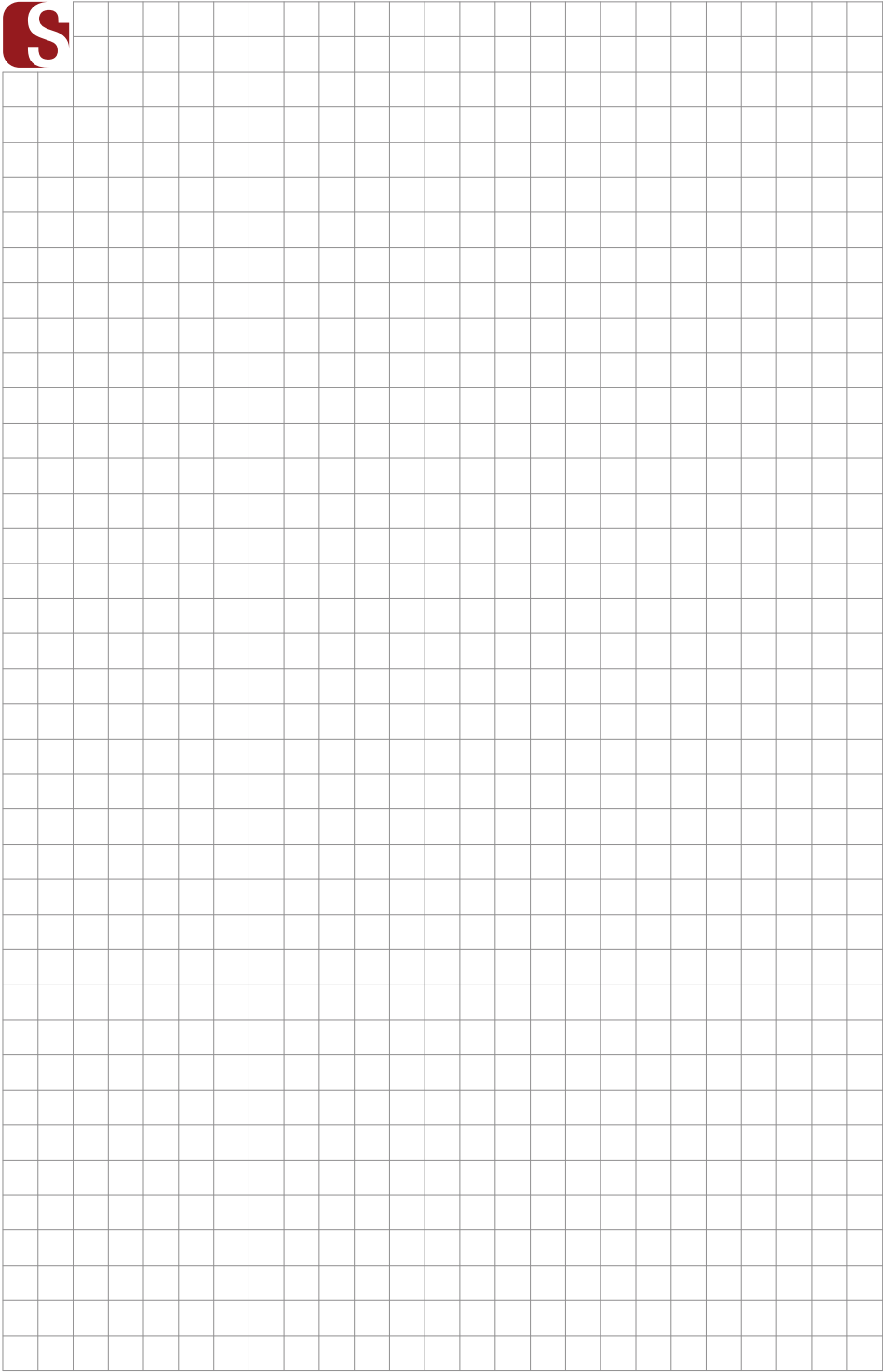

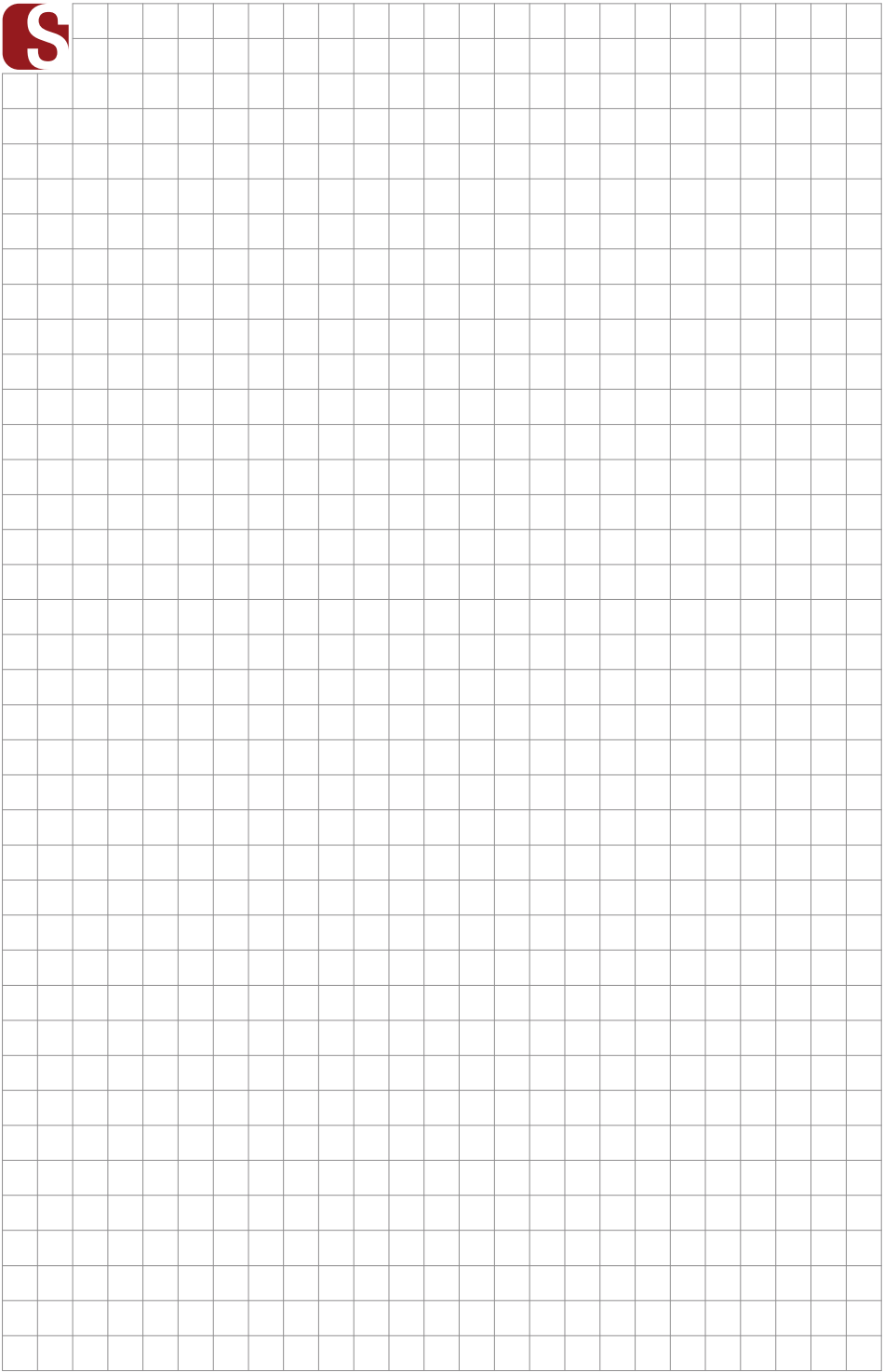

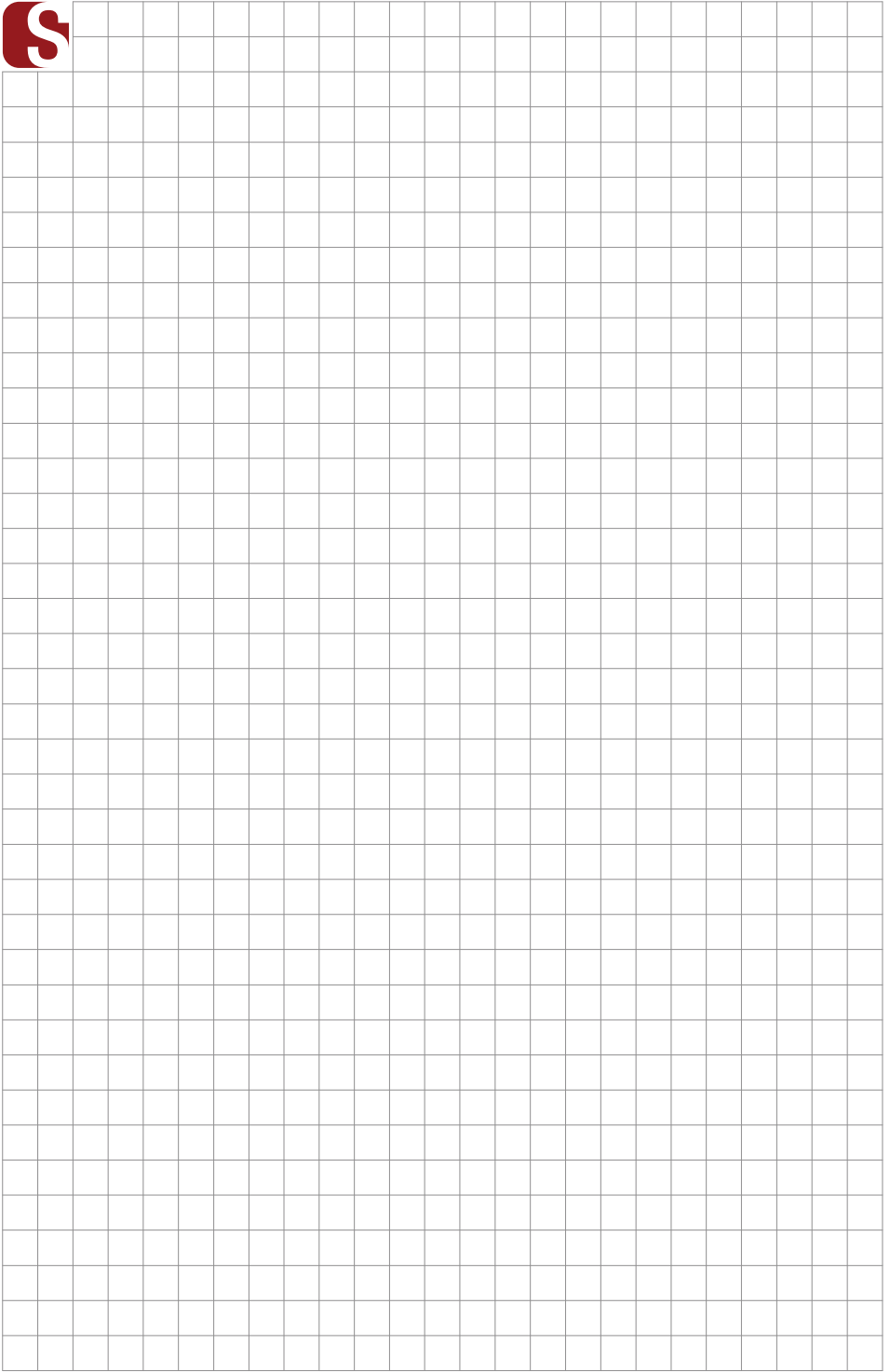

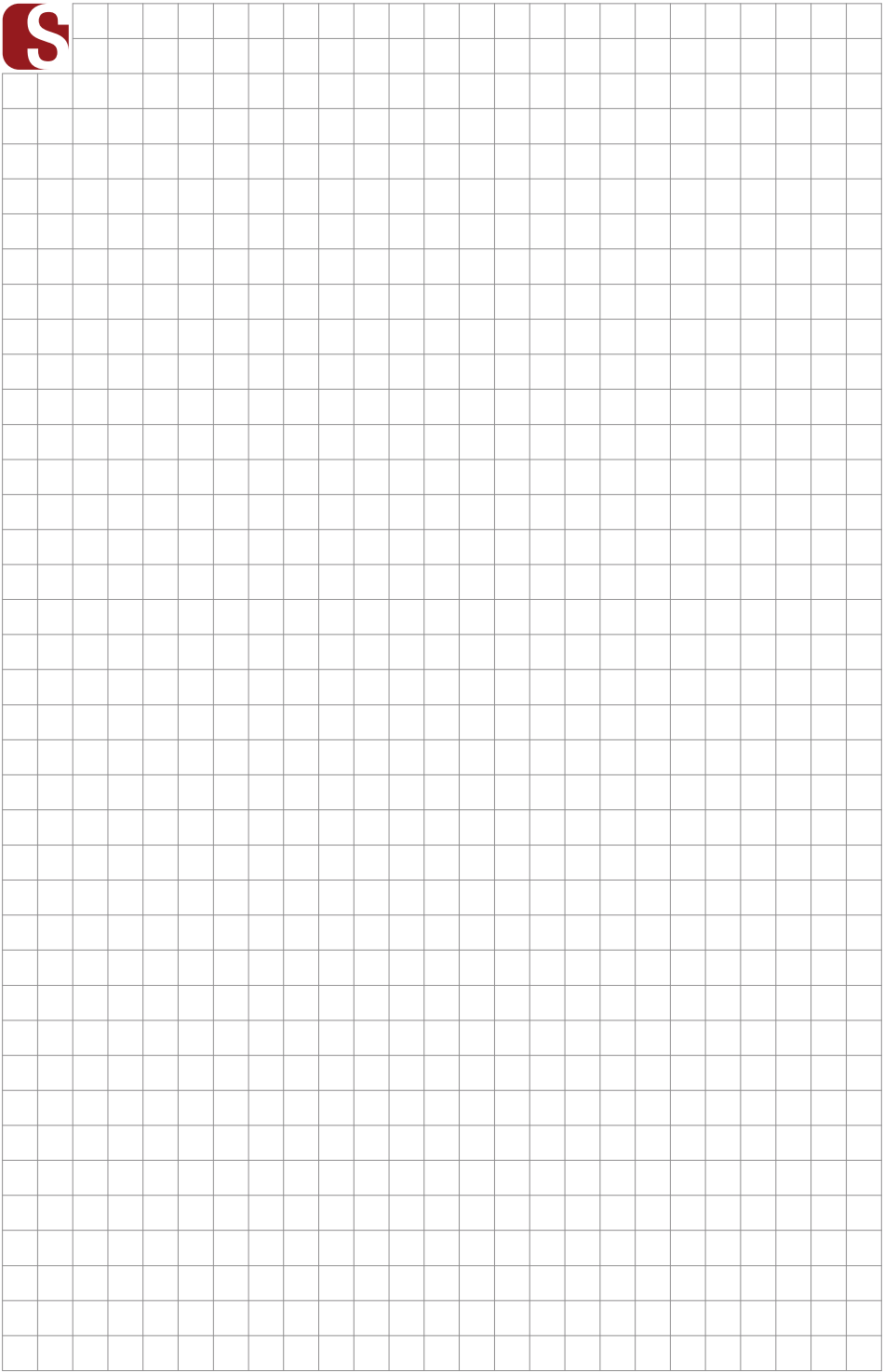



SLIGHT®

Chemin de la Veyre d'en haut D2

1806 St-Légier — Switzerland

+41 21 925 38 88

www.slight.ch

info@slight.ch